



Schindler 2600

The best way to act with intelligence is through experience. Our freight elevators are proof of that.



With the Schindler 2600, you've got flexibility.

The elevator adapts itself to fit your needs, from its size to its equipment features and operation – whether it's in industrial buildings, warehouses, shopping centers, schools, or buildings for the healthcare industry.



Versatility

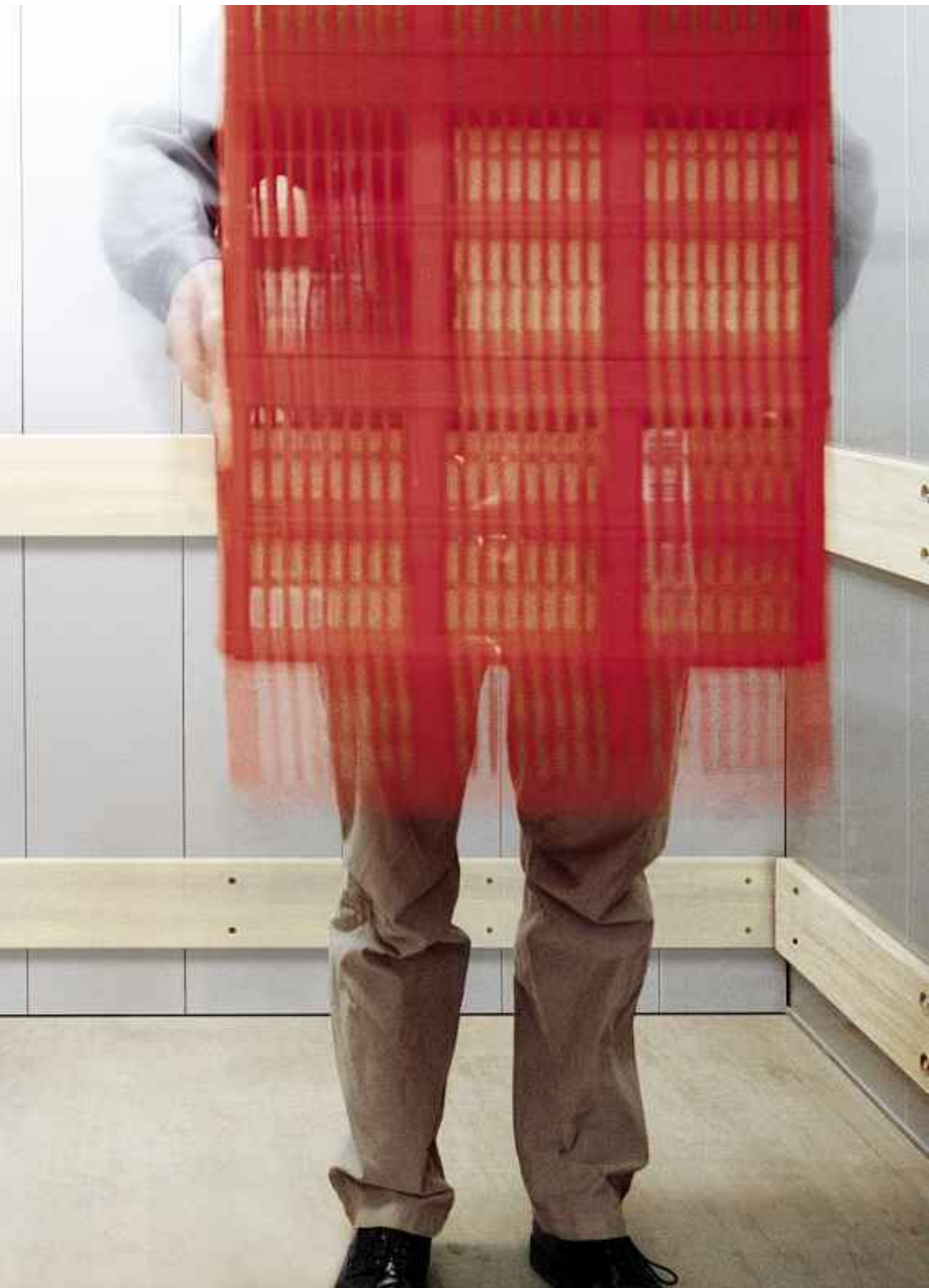





Availability

With the Schindler 2600 you set the pace.
The elevator runs when you like and for as long as you like, thanks to permanent monitoring, around the clock.

A close-up photograph of a wooden handrail mounted on a grey metal wall. The handrail is made of light-colored wood and is secured with screws. The wall has a vertical ribbed texture. The perspective is from a low angle, looking down the length of the handrail.

Longevity

You can rely on the Schindler 2600.

Robust technology, highly developed modules, high-quality materials and practical protection features make the elevator a durable, high-quality asset.





As high-tech as possible. But no more than necessary.

Heavy loads are lightened

You want to transport heavy cargo and goods? At a quick pace and over the long term? Then the Schindler 2600 is the ideal choice for you. We've equipped the elevator with great load-bearing capacity to meet a wide range of requirements. It fits as well in a warehouse as it does in a shopping center or in an industrial plant. It solves complex transport tasks anywhere simply, flexibly, durably, and cost-effectively.

Complex tasks are achieved with simplicity

With the Schindler 2600, we rely on consistent system engineering and high standardization. For this reason, we've given this elevator a modular construction. It is based on pre-assembled components that reflect the latest technology. The elevator's availability is absolutely reliable. Depending upon your needs and the site where it is to be used, the drive may be electromechanical or electro-hydraulic.

Continuous monitoring

We monitor the system 24 hours a day, 365 days a year. That way, problems can be corrected before they affect you – even at night.

A flexible palette

The Schindler 2600 saves you time and money. Predefined components and mandatory data make for ease of planning and shorten delivery times, for a single system or a group of up to four elevators. The Schindler 2400 service elevator and the Schindler 2500 bed elevator belong to the same platform as the freight elevator.

Notice

We reserve the right to make technical modifications and to alter specifications, options and colors.

All cars and options presented in this brochure are intended to serve as representations of our products. Colors and materials as shown may vary from the original.

Basic data

Load capacity	1000–6300 kg, 13–84 persons
Travel height	65 meters; max. 21 stops
Entrance	One-sided or two-sided access
Door width	900–3200 mm
Door height	2000–2500 mm
Drive	Roped or hydraulic
Speed	0.15 to 1.6 meters per second
Control	Collective control for groups up to 4; registered-destination control
Equipment	Flexible range of equipment

Performance and efficiency are combined to create a sustainable system.

Like no one else IKEA represents uncomplicated, modern living with an emphasis on the sustainability of its products – and its buildings. Like the IKEA located in Spreitenbach, Switzerland, which is certified according to the latest Swiss “min-energy” standard.

Moving goods and people to make IKEA’s showrooms come to life every day is a logistical challenge – and needs reliable and environmentally friendly technology. Whether it is plants, toys or furniture like the popular “Billy” the Schindler 2600 does the job. This elevator makes sure everything is transported swiftly and safely.

We want to create a better everyday life for our customers. Caring for the environment is part of it.



We finally found what we were looking for. Well-designed, functional and affordable.



We support sustainability

Let us make your building more sustainable. We designed the Schindler 2600 to be highly efficient in performance and energy usage. For us every detail counts.

We care for the environment

The daily operation of a building has the biggest impact on the environment – the same applies to elevators. That’s why we made sure that the Schindler 2600 is energy efficient during operation. Using less energy conserves our natural resources and lowers overall building costs.

We focus on efficiency

The Schindler 2600 is a fully engineered, smart system. It is robust enough to transport heavy goods yet uses the minimum energy to do so. All parts are perfectly adjusted to each other. From drives, to controls, to doors and to cabins – each and every component contributes to this elevator’s efficiency.

We assess our elevators

How do you know that this elevator is energy efficient? We measure it. Ratings run by independent third parties show the Schindler 2600 can provide an energy efficiency classification in the “green” range. It is always good to rely on facts.

Total environmental impact % by product phase

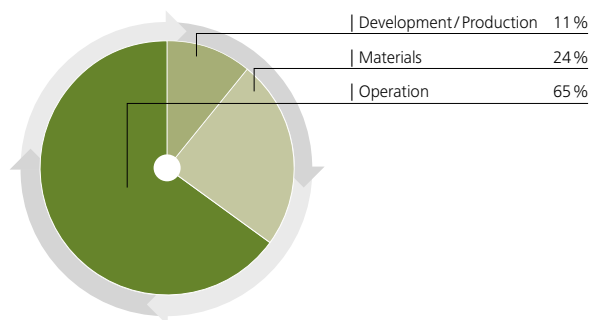

The energy consumed while an elevator is in service (operation phase) accounts for two-thirds of its environmental impact.

Energy efficiency classes

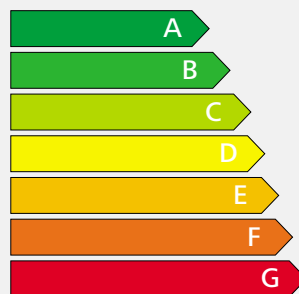

The measurement standard is VDI 4707 established in March 2009 by the Association of German Engineers. Energy efficiency classification can vary depending on elevator configuration.

Like us you have modest requirements. Merely to master every task with perfection.

Traction elevator system

The Schindler 2600 can be driven electro-mechanically for loads of 1000 kg to 4000 kg. This traction elevator system is especially suitable for complexes with high levels of traffic. Where multiple elevators neighbor each other, coordinating them with each other can increase the efficiency of transport. The freight elevators can operate with up to 4 tons without a machine room. That saves significant space in buildings.

Drive

The highly efficient permanent-magnet drive of the Schindler 2600 runs without gears allowing for a smooth, quality ride. Because it is relatively small and functions quietly, it represents the ideal solution for a machine room-less elevator. It enables direct power transfer, avoiding loss of power. The frequency-controlled drive achieves a high stopping accuracy and enables a direct power transfer avoiding a loss of power. By allowing a stable start without a high peak current, it quickly reaches a low energy consumption level.

Control

The microprocessor control of the Schindler 2600 performs a wide variety of tasks for individual systems as well as for groups of up to four elevators. The control is built into the door frame, which saves space. The system switches the car lights and ventilation into stand-by mode when not in use. Multi-bus control architecture reduces cabling, material and waste. For an efficient and short ride time for goods and passengers, you may select from the following typical control types: Pick-up, up or down collective, or collective/selective control for groups of up to four elevators. More than 100 standard control options are available.

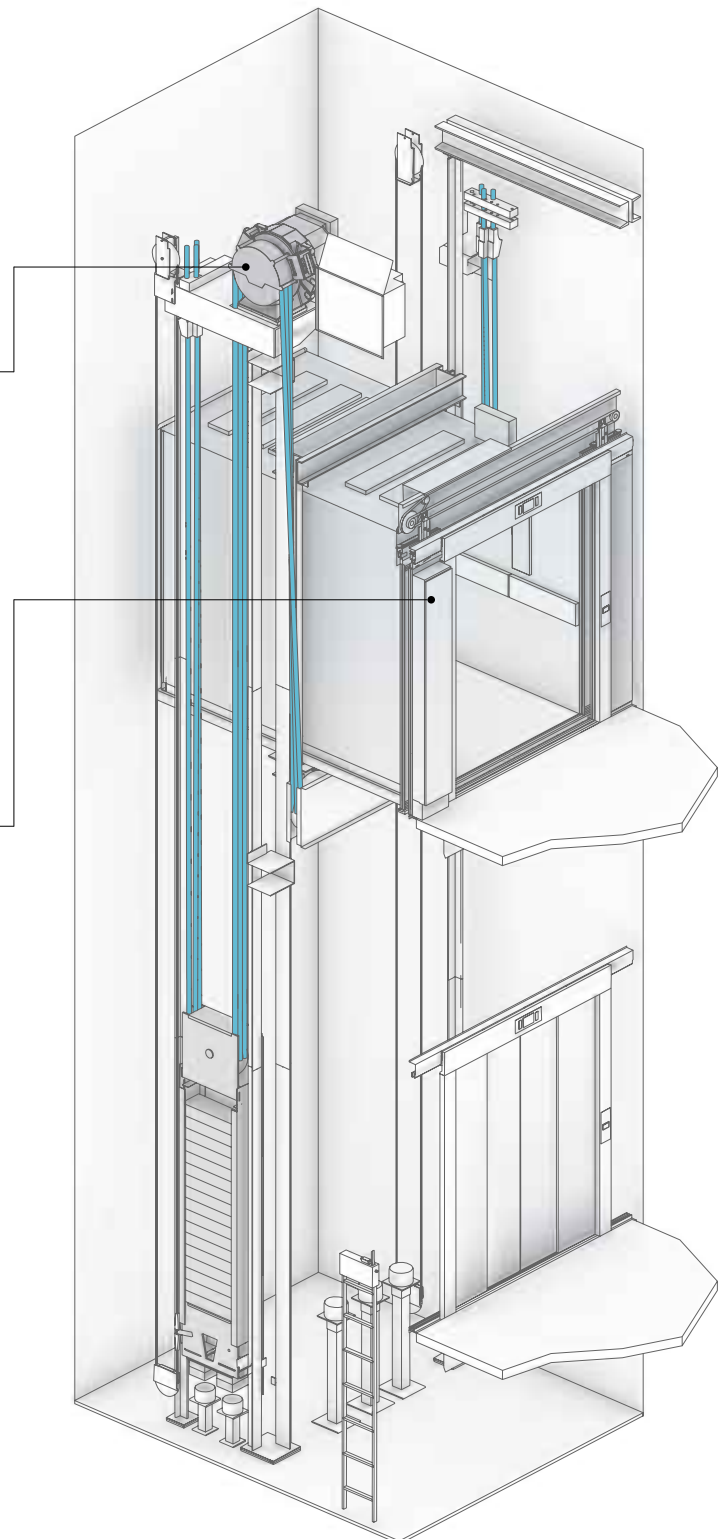

Machine room-less traction elevator

Hydraulic elevator system

The Schindler 2600 can be driven electro-hydraulically with a load of 1000 kg to 6300 kg. The hydraulic elevator system offers an extraordinarily economical solution for low rise buildings up to 18 m, particularly for single applications and for transporting heavy loads.

Drive

The Schindler 2600 possesses a unique drive system. It consists of a pump unit and an electronically controlled valve. Combined with the integrated control, it easily fulfills the high demands of a heavy freight elevator. The drive allows quick adjustments, which can help offset short up-and-down movements during loading of the car. Goods are transported without damage. The drive achieves excellent stopping accuracy. The hydraulic version of the Schindler 2600 also displays low energy consumption.

Control

The specially designed microprocessor control is suitable for a wide variety of needs and uses. It offers fully regulated control, which produces short ride times. You may select from the following typical control types: Pick-up, up or down collective, or collective/selective control for groups of up to four elevators. More than 100 control features are available as standard options.

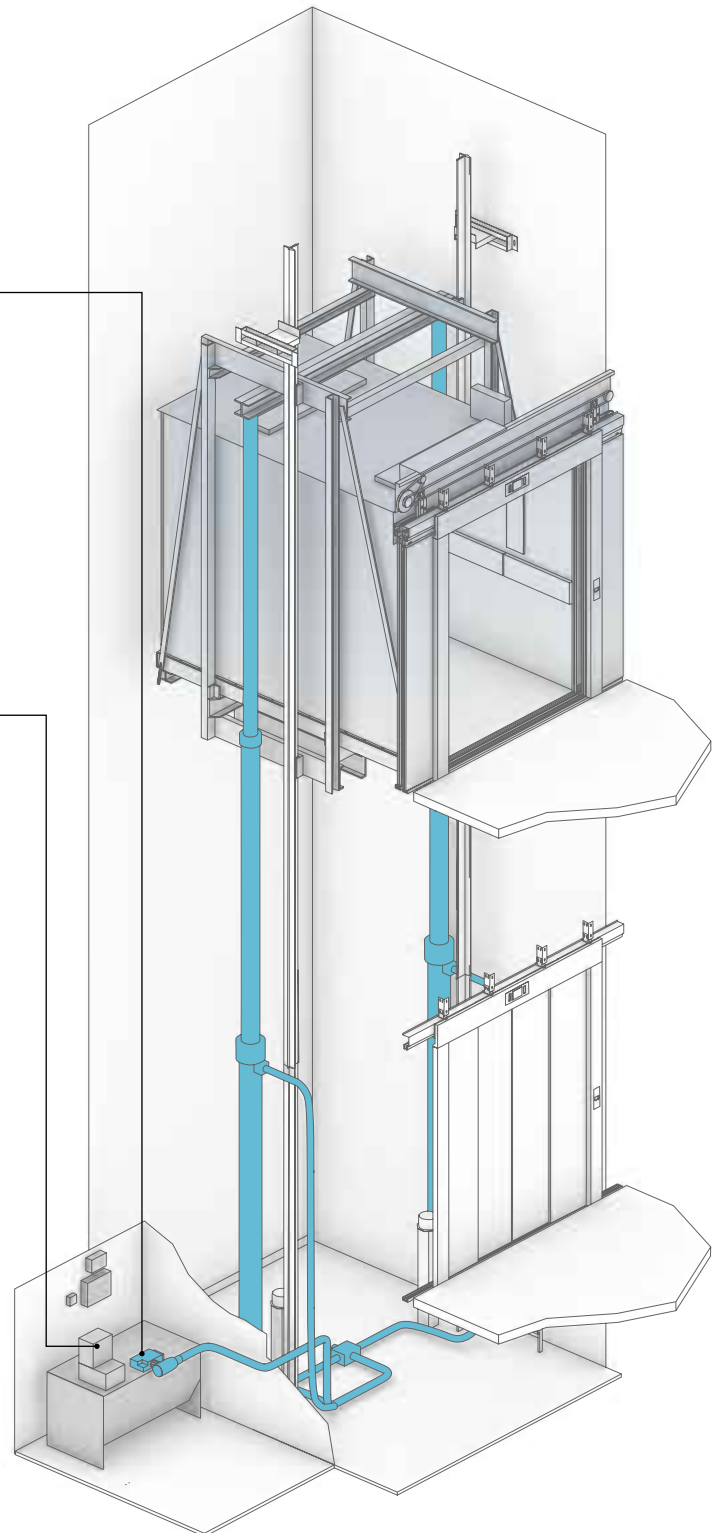

Tandem hydraulic drive

The future can't be made to order, but it can be created by you. So go right ahead.

Drive	Load capacity		Speed		Travel height max.		Number of stops max.		Nominal rating		Nominal current			Car			Door			Shaft	
	GQ kg	Passengers	VKN m/s	HQ m	ZE	PMN kW	INN A	BK mm	TK mm	HK mm	Type	BT mm	HT mm	HSG mm	HSK mm						
Traction*	1000	13	1.0	50	21	10.8	23	1000–1600	1400–2350	2000–2500	T2/C2/C4	900–1600	2000–2500	1500	HK + 1500						
			1.6	65		18.9	31							1700	HK + 1650						
	1275	17	1.0	50	21	11.1	29	1100–1800	1500–2650	2000–2500	T2/C2/C4	1000–1800	2000–2500	1500	HK + 1500						
			1.6	65		16.1	36							1700	HK + 1650						
	1600	21	1.0	25	21	11.5	30	1200–2100	1500–2900	2000–2500	T2/C2/C4	1100–2100	2000–2500	1500	HK + 1500						
			1.6	25		17.4	39							1700	HK + 1650						
	2000	26	1.0	25	21	15.3	39	1400–2300	1650–2950	2000–2500	T2/C2/C4/C6	1300–2300	2000–2500	1500	HK + 1500						
			1.6	25		24.3	53							1700	HK + 1650						
	2500	33	1.0	25	21	20.2	42	1400–2300	2050–3500	2000–2500	T2/C2/C4/C6	1300–2300	2000–2500	1700	HK + 1700						
	3000	39	1.0	24	21	23.3	48	1500–2300	2350–3800	2000–2500	C4/C6	1400–2300	2000–2500	1700	HK + 1700						
3200	42	1.0	24	21	23.4	48	1700–2400	2350–3550	2000–2500	C4/C6	1600–2400	2000–2500	1700	HK + 1700							
3500	46	1.0	24	21	25.4	52	1800–2400	2550–3600	2000–2500	C4/C6	1700–2400	2000–2500	1700	HK + 1700							
4000	53	0.8	24	21	24.2	53	1800–2500	2800–4000	2000–2500	C4/C6	1700–2500	2000–2500	1700	HK + 1700							
Hydraulic Rucksack**	1000	13	0.63	18	8	16	38	1000–1600	1300–2350	2000–2500	T2/C4	900–1600	2000–2500	1350	HK + 1350						
	1275	17	0.63	18	8	20	45	1100–1800	1450–2600	2000–2500	T2/C4	1000–1800	2000–2500	1450	HK + 1350						
	1600	21	0.63	18	8	33	73	1200–1500	1950–2900	2000–2500	T2/C4	1100–1500	2000–2500	1450	HK + 1350						
Hydraulic Tandem**	1600	21	0.63	18	8	33	73	1550–2100	1500–2250	2000–2500	T2/C2/C4	1400–2100	2000–2500	1150	HK + 1350						
	2000	26	0.40/0.63	18	8	33	73	1400–2300	1650–2950	2000–2500	T2/C2/C4/C6	1300–2300	2000–2500	1150	HK + 1350						
	2500	33	0.40/0.63	18	8	47	98	1400–2300	2050–3500	2000–2500	T2/C2/C4/C6	1300–2300	2000–2500	1250	HK + 1350						
	3000	39	0.25–0.63	18	8	47	98	1500–2300	2350–3800	2000–2500	C4/C6	1400–2300	2000–2500	1250	HK + 1350						
	3200	42	0.25–0.63	18	8	47	98	1700–2400	2350–3550	2000–2500	C4/C6	1600–2400	2000–2500	1250	HK + 1350						
	3500	46	0.25–0.63	18	8	60	123	1800–2400	2550–3600	2000–2500	C4/C6	1700–2400	2000–2500	1250	HK + 1350						
	4000	53	0.15–0.63	18	8	60	123	1800–2500	2800–4000	2000–2500	C4/C6	1700–2500	2000–2500	1250	HK + 1350						
	5000	66	0.15–0.40	15	8	47	98	1800–3100	2700–4900	2000–2500	C4/C6	1700–3100	2000–2500	1350	HK + 1350						
	6300	84	0.15/0.25	15	8	40	86	2000–3200	3000–5500	2000–2500	C4/C6	1900–3200	2000–2500	1350	HK + 1350						

GQ Load capacity
VKN Speed
HQ Travel height
ZE Number of stops
PMN Nominal rating
INN Nominal current

*1 With or without machine room
*2 Machine room under, over, or to the side; max. 10 m from shaft
*3 Higher travel heights up to 50 meters on request
*4 Maximum values

BK Car width
TK Car depth
HK Car height

*5 Car dimensions in 50-mm increments, the maximum allowed car area according to EN81 must be considered

T2 Telescopic door, two-part
C2 Center-opening telescopic door (two-part)
C4 Center-opening telescopic door (four-part)
C6 Center-opening telescopic door (six-part)
BT Door width
HT Door height

*6 Door dimensions in 100-mm increments

HSG Shaft pit depth
HSK Clear overhead below lifting beam

*7 Minimal values, in hydraulic variation must be increased in measure according to the configuration

Max. number of entrances: 2, opposing
Number of rides (rope): 180 per hour
Number of rides (hydraulic): 30/60 per hour
Power supply: 400 V; optional 230 V

Shaft width/depth: In the planning section on pages 20–23, ranges shown reflect typical elevator situations.

Car

The car's construction is custom-tailored, so that it perfectly fits the intended site for its use in width, depth and height. The car dimensions can be flexibly selected in 50 mm increments. Car frames make the car extremely stable.

Door

We construct the ideal, custom-designed door for your needs – with two, four, or six panels. They efficiently exploit the width of the shaft and can be exactly as high and as wide as the car. This produces a number of advantages. Loading and unloading the car is convenient, and damage to the doors is avoided. The opening and closing speed of the doors can also be adjusted.

Standards

The Schindler 2600 is certified according to the Lift Directive 95/16/EC. In addition, it fulfills all relevant standards:

- EN81-28 Remote emergency calling system for passenger and cargo elevators
- EN81-58 Fire-resistant landing doors
- EN81-71 Protective measures against intentional destruction (optional vandal-proof buttons and car equipment features)





Environment

The Schindler 2600 meets the requirements of ISO 14001. Both the traction and the hydraulic versions display very good energy consumption values. With the hydraulic elevator, a unique drive system may be selected from standard options, which drastically reduces the consumption of energy in comparison with conventional hydraulic aggregates.

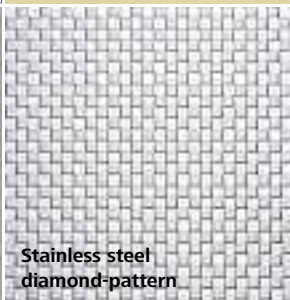

Monitoring

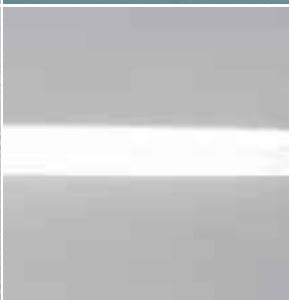
Control data can be continuously transmitted to our headquarters. Allowing the elevator to be monitored 24 hours a day, 365 days a year. And problems are corrected before they become a problem for you.

<p>Walls Car doors</p>	 <p>Paint Catania Yellow</p>	 <p>Paint Malmo Grey</p>	 <p>Paint Lübeck Blue</p>	 <p>Paint Aberdeen Green</p>
----------------------------	---	---	---	---

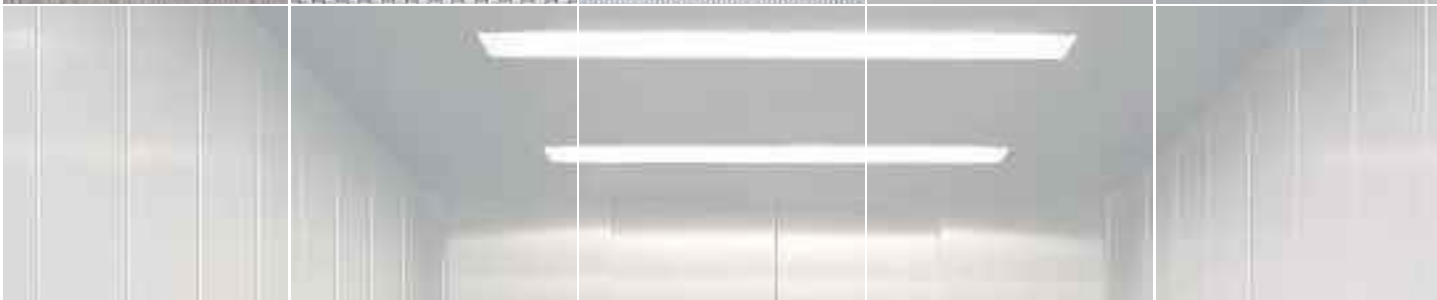
 <p>Stainless steel brushed</p>	 <p>Stainless steel diamond-pattern</p>	 <p>Stainless steel linen</p>		
---	--	--	--	---

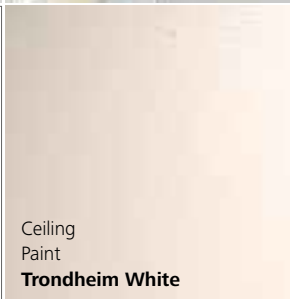
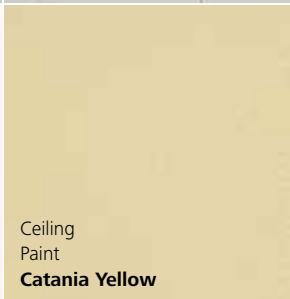
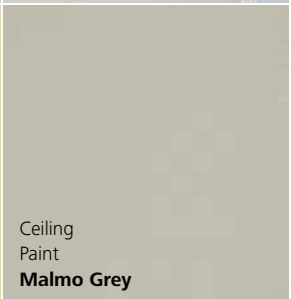

<p>Ceiling Floor</p>	 <p>Ceiling Paint Trondheim White</p>	 <p>Ceiling Paint Catania Yellow</p>	 <p>Ceiling Paint Malmo Grey</p>	 <p>Ceiling Stainless steel brushed</p>
--------------------------	---	--	---	---

 <p>Floor Aluminum treadplate</p>	 <p>Floor Steel treadplate, primed grey</p>	 <p>Floor Stainless steel treadplate</p>	 <p>Floor Anti-slip coated wood</p>	
--	---	--	--	---

Practical design is design made to serve an idea. Discover it for yourself.

The Schindler 2600 is not only extremely robust, functional, and user-friendly, but it also has an attractive appearance. You may select and combine the standard materials and colors precisely according to your requirements. Upon request, we can also offer other versions at similar delivery and price conditions.

The walls, cars, and landing doors for the standard version are constructed from either stainless steel or are painted gray. The materials for the paneling are extremely durable, as is the slip-proof and easy-care floor.

The standard flooring consists of high-grip treadplate made of stainless steel, aluminum, primed gray steel, or is made of wood.

The ceiling in the standard range may be painted in white or constructed of brushed stainless steel. The car lighting is countersunk into the ceiling, which means they cannot be damaged by tall items.

There's nothing more refined than simplicity. Especially when it comes to complex tasks.

Car and hall fixtures

The freight elevator has a flat, integrated button control panel in the car. It is installed flush with the car wall and thus protected from damage that can result from loading and unloading. The car and hall control panels are constructed from stainless steel. The button control panels in the car are also available in anthracite. Vandal-proof fixtures are also available as an option.

Hall control panels and floor indicators are mounted flush with the wall or are mounted in the door frames. The indicators can also be ordered with a gong sound.

Protective strips

The car is equipped with protective bumper guard strips around its circumference. They are constructed from

- wood,
- black plastic,
- brushed stainless steel, or
- are specially constructed according to your wishes.

The baseboards may also be selected in brushed stainless steel as an option.

Thresholds

Car and landing door thresholds are made of

- aluminum (for low usage volumes),
- galvanized steel or
- brushed stainless steel.

Overview of control panels



Floor level indicators
 – Standard
 – Vandal-proof



In-car fixtures
 – Stainless steel
 – Anthracite
 – Vandal-proof



Hall fixtures,
 individually configurable
 – 2-element
 – 5-element
 – Vandal-proof

Black plastic bumper guard



Stainless steel car control panel, vandal-proof



Technology can be complicated. But only when you can't see the underlying organizational structure.

Machine-room-less traction elevator with frequency-controlled drive
1000–4000 kg load capacity; 13–53 persons

Drive	Load capacity		Passengers max.	Speed	Number of entrances			Door			Shaft			
	GQ kg	VKN m/s			BK mm	TK mm	HK mm	Type	BT mm	HT mm	BS mm	TS mm	HSG mm	HSK mm
Traction	1000	13	1.0	1	1300	1750	2100	C4	1300	2100	2250	2150	1500	3600
				2								2280		
	1600	21	1.0	1	1400	2400	2100	C4	1400	2100	2350	2800	1500	3600
				2								2930		
	2000	26	1.0	1	1500	2700	2100	C4	1500	2100	2500	3100	1500	3600
				2								3230		
	2500	33	1.0	1	1800	2700	2500	C4	1800	2500	3100	3100	1700	4200
				2								3230		
	3500	46	1.0	1	2100	3000	2500	C4	2100	2500	3500	3400	1700	4200
				2								3530		
	4000	53	0.8	1	2200	3200	2500	C6	2200	2500	3400	3700	1700	4200
				2								3910		

GQ Load capacity
VKN Speed
HQ Travel height
HE_{min} Minimal interfloor distance

BK Car width
TK Car depth
HK Car height

T2 Telescopic door
C4 Center-opening telescopic door (four-part)
C6 Center-opening telescopic door (six-part)
BT Door width
HT Door height

BS Shaft width
TS Shaft depth
HSG Shaft pit depth
HSK Clear overhead below lifting beam

HE_{min} = HT + 740 mm for one-sided entrances
HE_{min} = 300 mm for staggered opposite entrances

For further details, such as offers, construction plans and prices, please contact our sales department directly.

Height and plan view

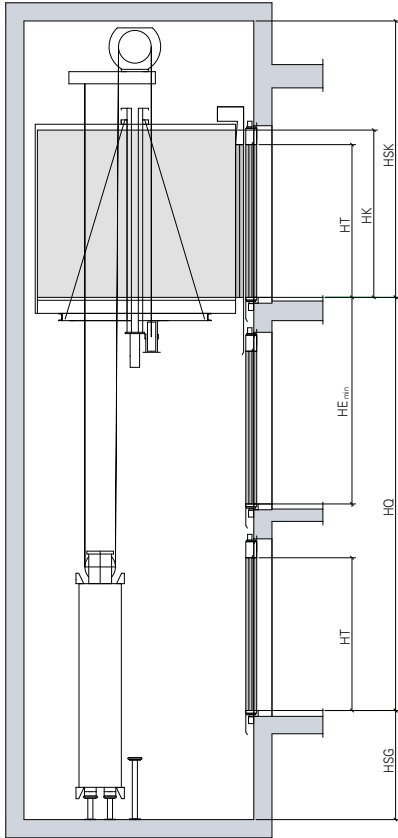

One-sided entrance

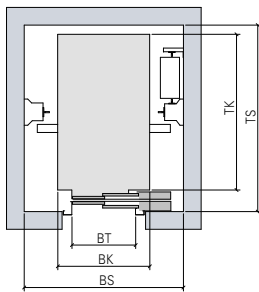

One-sided entrance
Telescopic door

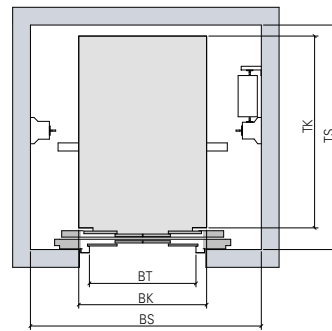

One-sided entrance
Center-opening telescopic door (four-part)

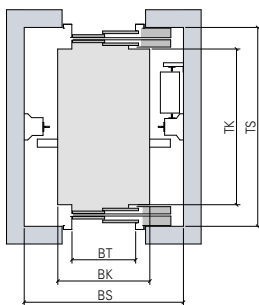

Two-sided entrance
Telescopic door

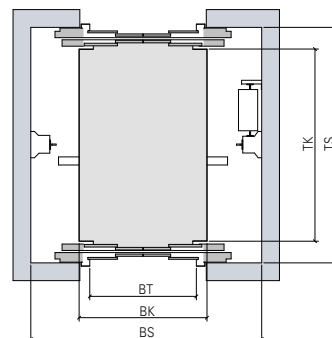

Two-sided entrance
Center-opening telescopic door (four-part)

The data is available. So that you can set the standard.

Hydraulic elevator with machine room
1000–6300 kg load capacity; 13–84 persons

Drive	Load capacity		Passengers max. Speed	Number of entrances			Door				Shaft			
	GQ kg	VKN m/s		BK mm	TK mm	HK mm	Type	BT mm	HT mm	BS mm	TS mm	HSG mm	HSK mm	
Hydraulic Rucksack	1000	13	0.63	1	1300	1750	2100	T2	1300	2100	2450	2150	1350	3450
				1				C4			2200			
				2							2280			
	1600	21	0.63	1	1400	2400	2100	C4	1400	2100	2400	2800	1450	3450
2										2930				
Hydraulic Tandem	2000	26	0.40	1	1500	2700	2100	C4	1500	2100	2500	3100	1150	3450
				2								3230		
	2500	33	0.40	1	1800	2700	2500	C4	1800	2500	2950	3100	1250	3850
				2								3230		
	3500	46	0.40	1	2100	3000	2500	C4	2100	2500	3400	3400	1250	3850
				2								3530		
	4000	53	0.25	1	2200	3200	2500	C6	2200	2500	3200	3700	1250	3850
				2								3910		
	5000	66	0.25	1	2500	3450	2500	C6	2500	2500	3600	3950	1350	3850
				2								4160		
6300	84	0.25	1	2500	4200	2500	C6	2500	2500	3600	4700	1350	3850	
			2								4910			

GQ Load capacity
VKN Speed
HQ Travel height
HE_{min} Minimal interfloor distance
BO Width of machine room
TO Depth of machine room

BK Car width
TK Car depth
HK Car height

T2 Telescopic door
C4 Center-opening telescopic door (four-part)
C6 Center-opening telescopic door (six-part)
BT Door width
HT Door height

BS Shaft width
TS Shaft depth
HSG Shaft pit depth
HSK Clear overhead below lifting beam

HE_{min} = HT + 740 mm for one-sided entrances
HE_{min} = 300 mm for staggered opposite entrances

For further details, such as offers, construction plans and prices, please contact our sales department directly.

Height and plan view

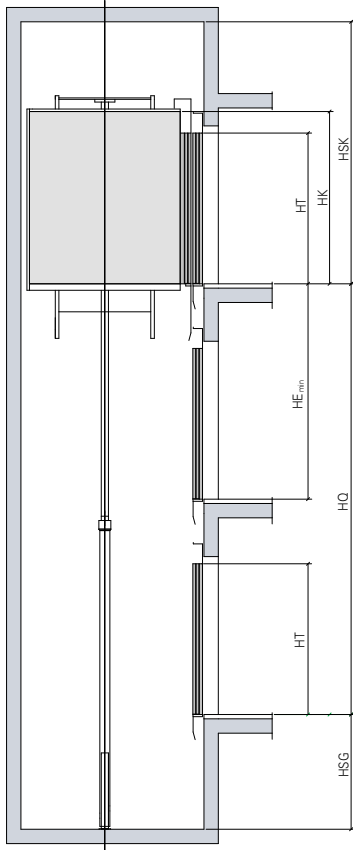

One-sided entrance
Rucksack system

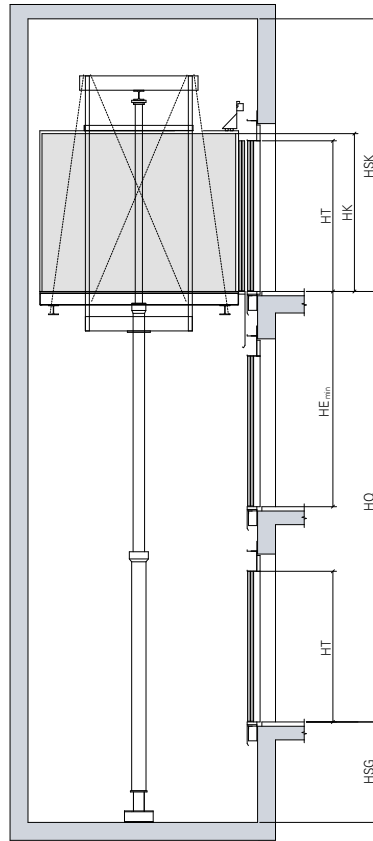

One-sided entrance
Tandem system

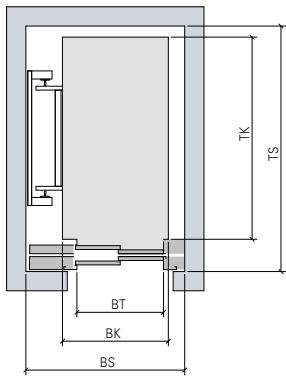

One-sided entrance
Telescopic door

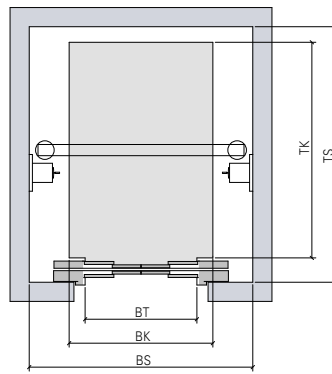

One-sided entrance
Center-opening telescopic door (four-part)

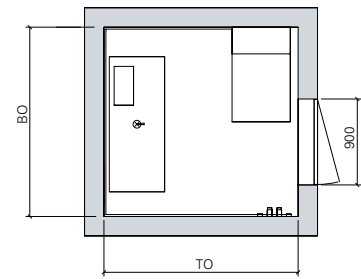

Machine room

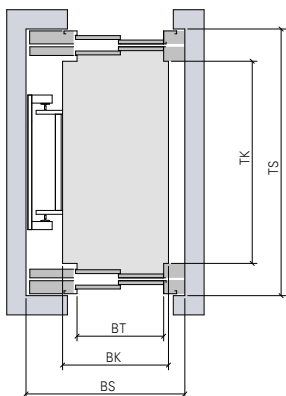

Two-sided entrance
Telescopic door

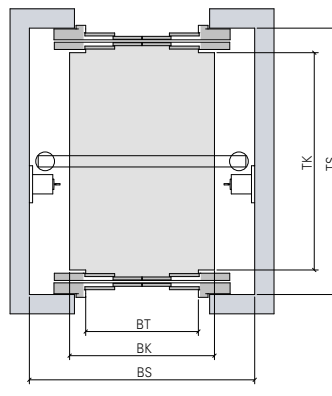

Two-sided entrance
Center-opening telescopic door (four-part)

We shorten reaction times by being nearby. Your nearest distributor is never far away.

For further information including the location
of the distributor nearest you, please visit:

www.schindler.com