

Schindler 9300. The Escalator.
Enjoy moving.



We set a new standard for mobility

Schindler 9300

Protect and support

Safety and reliability—these are our top commitments.

Respect and optimize

Reduced energy with increased efficiency—this is our design approach.

Enlarge and compose

New compact design for more building space.

Enhanced beauty

Enhance and complement aesthetics to suit your architectural needs.



Protect and support

Safety and reliability are our prime commitments. Schindler 9300 offers state-of-the-art safety solutions to protect and support your passengers.



Advanced safety solutions

Schindler escalators are designed to meet the most stringent safety requirements over their entire product life cycles—from production through installation to maintenance. The new Schindler 9300 escalator provides enhanced safety features to protect your passengers.

Code compliance

The TÜV-certified Schindler 9300 escalator meets all international standards including EN 115, GB 16899, HK-COP, ANSI, and others.

Passenger guidance

Schindler 9300 is designed to guide young and elderly passengers safely on their way to the next floor. Full visual guidance is provided by moving LED direction indicators **1**, fire-resistant step demarcations **2**, yellow signal combs **3**, and LED step gap lighting **4**.

Intelligent braking system

With the brake torque adapted to the direction of travel, Schindler's unique braking system minimizes the risk of passengers falling during emergency stops.

Built-in system safety

The MICONIC F escalator controller double-checks each safety device in real time. Speed and direction are monitored on the motor shaft **1**, step band **2**, and handrail **3**. By monitoring three separate components, a failure-free anti-reversal check is ensured.

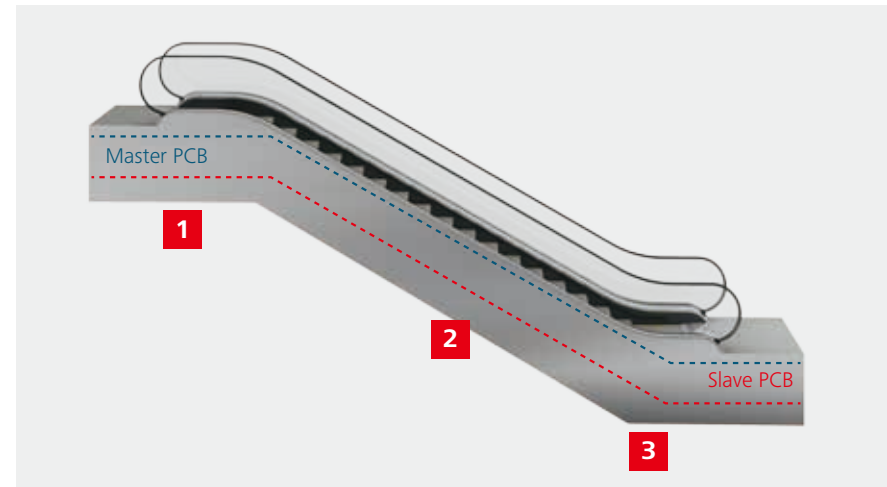
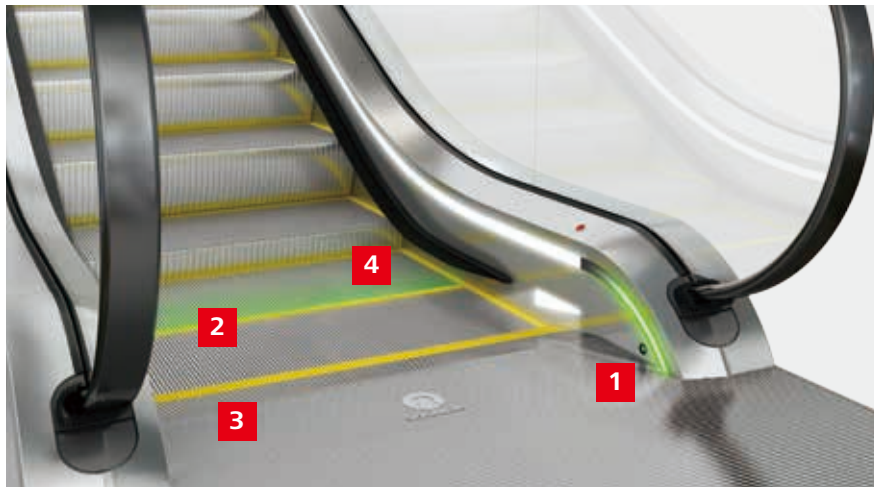



Would you like more information on safety?
Please consult the Schindler escalator safety
brochure *State of the Art*.

Strong, durable components

Schindler 9300 components are selected to secure high reliability and long service life. It is the key components which make the difference.

Improved compact and reinforced truss

The new truss design with open profiles provides long-lasting corrosion resistance of up to 40 years. The vibration-isolated end supports eliminate sound transmission to the building.

Break-resistant aluminum compact steps

Steps are the most important safety component. The Schindler monoblock step provides significantly higher break resistance at substantially lower step weight compared to multipart compound steel steps.

Ergonomic handrail with increased breaking load

Even small hands can comfortably hold the new ergonomic handrail. The new design combines high flexibility with strength and ensures a long service life.

Durable drive and step chains

Schindler drive and step chains comply with national and international standards. The lubrication system is controlled by MICONIC F, which ensures a long service life and high operational efficiency.

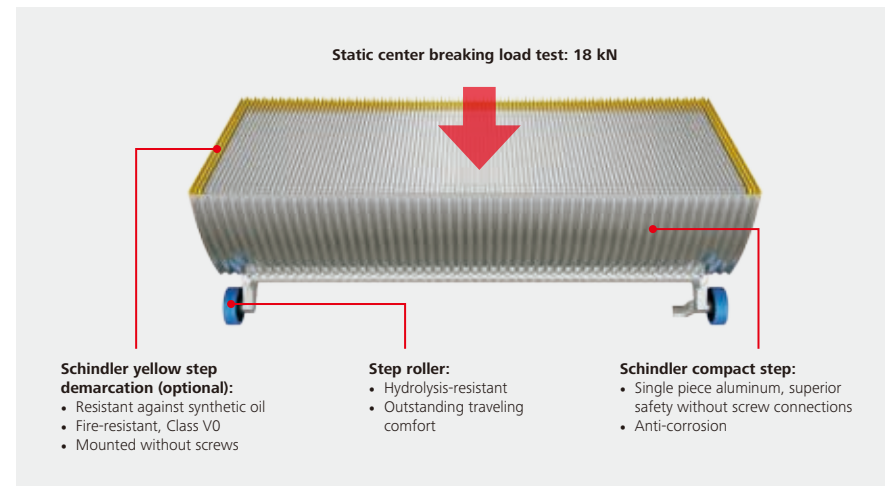
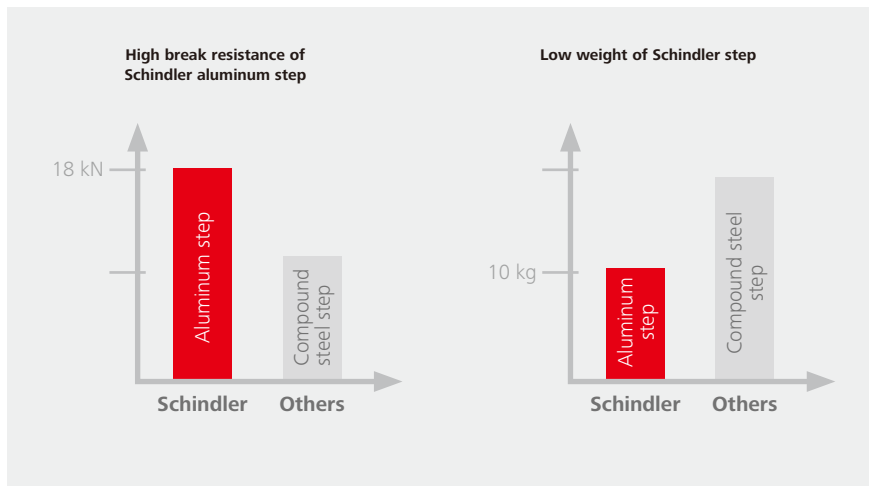



Respect and optimize

Reduced energy with increased efficiency. Our new drive system, in combination with three ECO operating modes, offers a high-performance mobility solution. For Schindler 9300, this ensures an extended lifespan, a reduced CO₂ footprint, and an ISO energy rating of A+++¹⁾.



¹⁾In accordance with the ISO 25745-1/3 standard; for more details, see the footnote on ISO 25745-1/3 on the next page.

Total drive efficiency in every detail

Each individual drive component (gearbox, motor, brake, flywheel, and drive chains) is designed to save energy. Schindler 9300 is designed to meet your LEED or BREEAM building certification requirements.

Innovative drive system design

The new drive system family of Schindler 9300 enables higher vertical rises and ensures a longer service life, at the same power level.

Choose our optional premium power package for optimized energy efficiency with IE3 motor and high-efficiency gear

For Schindler 9300, with the IE3¹⁾ motor and the high-efficiency gear, the energy efficiency class (measured by the ISO 25745-1/3 standard) is A+++²⁾.

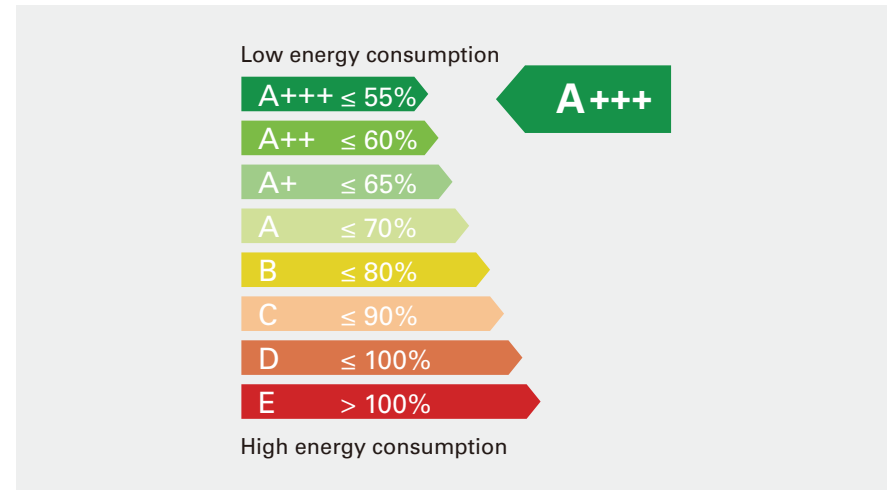

¹⁾ The efficiency factor of the IE3 motor corresponds to IEC 60034-30.

²⁾ The ISO 25745-1/3 standard regarding energy calculation and classification of escalators and moving walks is established by the International Organization for Standardization (ISO). The ISO 25745-1/3 classes range from "A+++ to "E," with class "A+++ being the most energy-efficient class. The given result is based on measurements and valid for a Schindler 9300 escalator with a step width of 1 m, a rise of 3,97 m, an angle of inclination of 30°, a speed of 0.5 m/s, and with optional energy-saving features. The ISO 25745-1/3 classification and energy consumption of individual installations may deviate from this result, e.g., due to different or additional customer options and/or different configurations.



Would you like more information on efficiency? Please consult the Schindler escalator efficiency brochure *Performance is not a question of consumption.*

Smart power management with clever eco-options

Schindler's ECO system for smart power savings

Load determination is optimized by constantly checking the load of passengers on the escalator. As a result, the motor operates according to the load, i.e., the number of passengers, in an efficient power window.

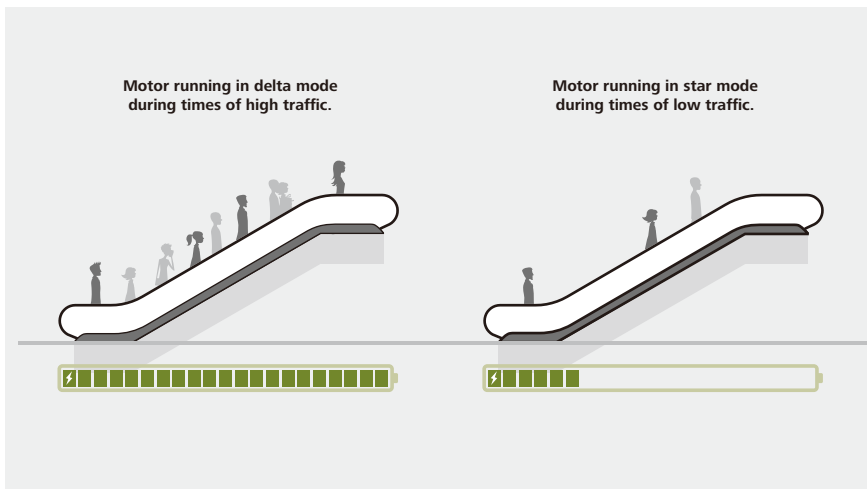

Schindler ECOLINE¹⁾ power management packages: clever eco-options for low-cost operation

In addition to the standard ECO saving system, optional energy-saving features are available: stop-&-go operation, stand-by speed operation, or a combination of both features allow substantial additional energy savings.

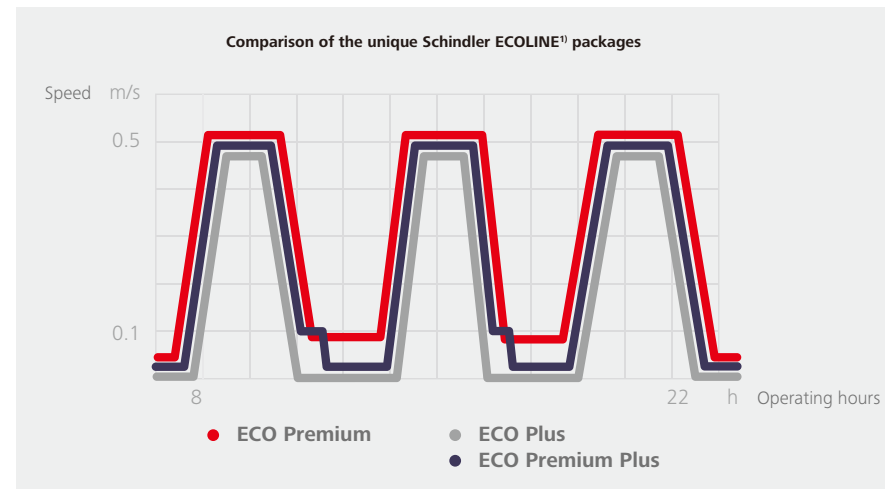

¹⁾ ECO = Energy savings in Continuous Operation



Enlarge and compose

New compact design for more building space. More space at entry and exit areas, reduced overall width, and 3D automatic planning tools enable efficient escalator positioning and provide more rental space in your building.



Enlarge rental space

More space at entry and exit

The balustrade has been shortened by 336 mm so that more space can be offered in front of the escalator at each landing.

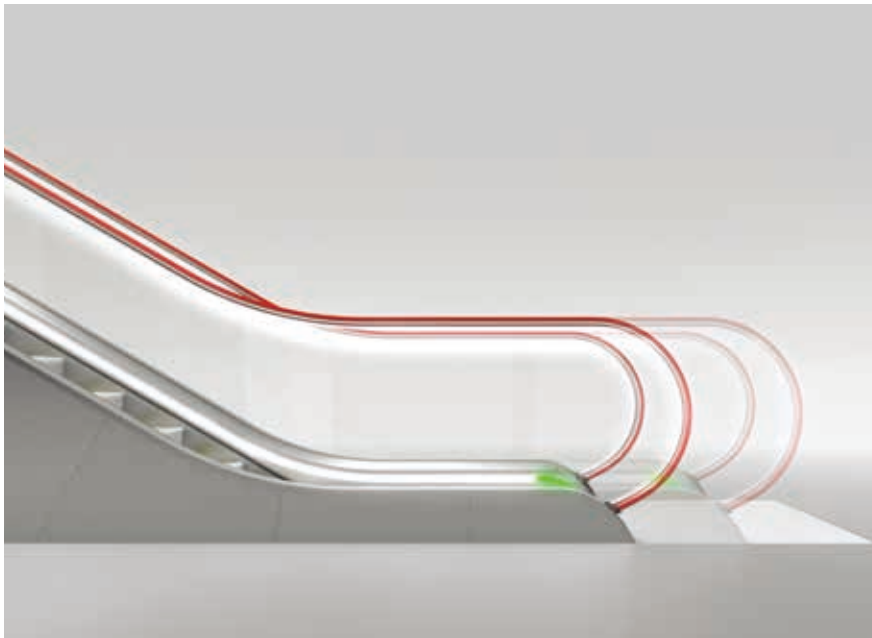

Designed for optimizing space

Reduction of overall escalator width

While retaining the same nominal step width, the overall width of the escalator has been reduced by 75 mm, resulting in more rental space in your building.



Compose your building

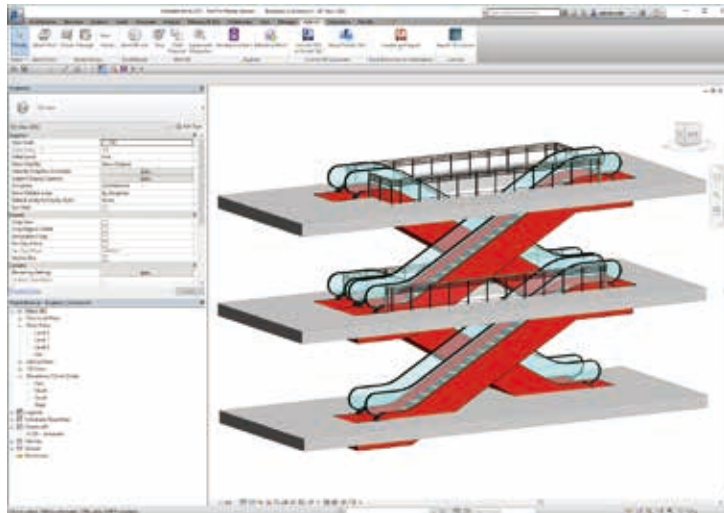

Schindler provides up-to-date planning tools for architects, planners, and consultants. 2D drawings and 3D models are provided by the DigiPara Elevatorarchitect plug-in for Autodesk Revit available at the Autodesk App Store.



DigiPara® Elevatorarchitect
for Autodesk® Revit®

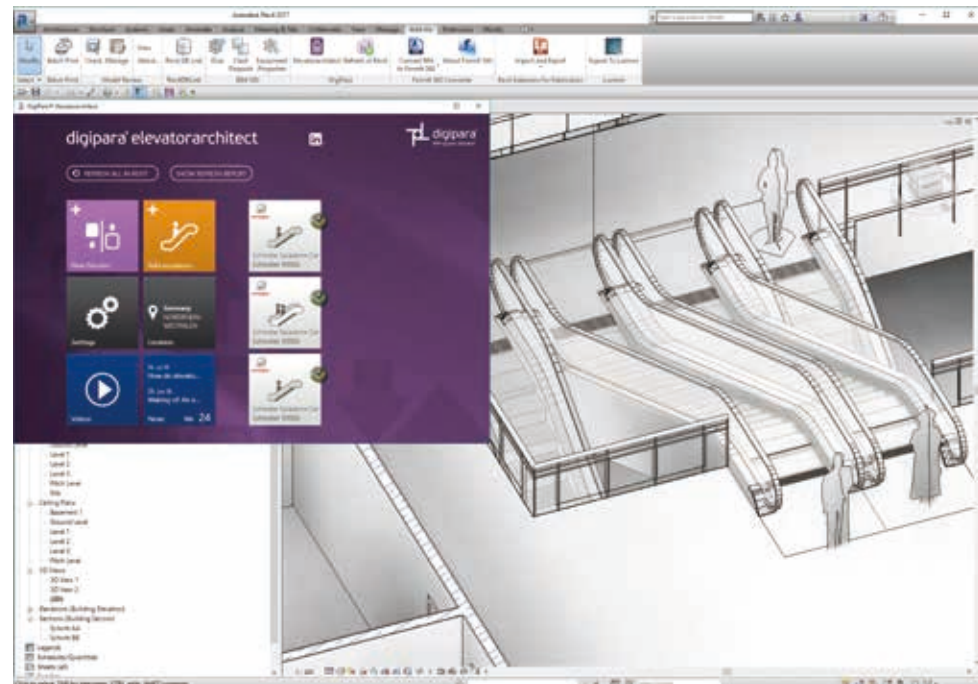



Enhanced beauty

Contemporary aesthetics complement your architectural needs. Timeless design combined with a range of unique decorative options can distinctively enhance your building environment.





Premium beauty package

- 1 Direction indicator
- 2 RGB LED balustrade & skirt lighting with 16.7 million individual colors
- 3 Triangular combplate lighting
- 4 Stainless-steel newel end cap

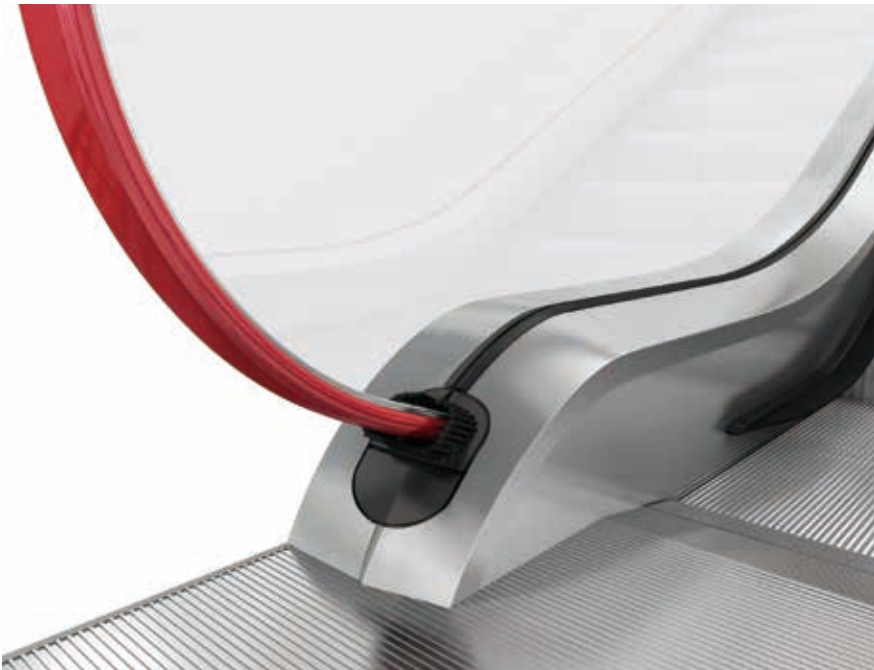

Stainless-steel newel end cap



Polyamide newel end cap



Aluminum floor cover with line pattern (white anodized grooves)

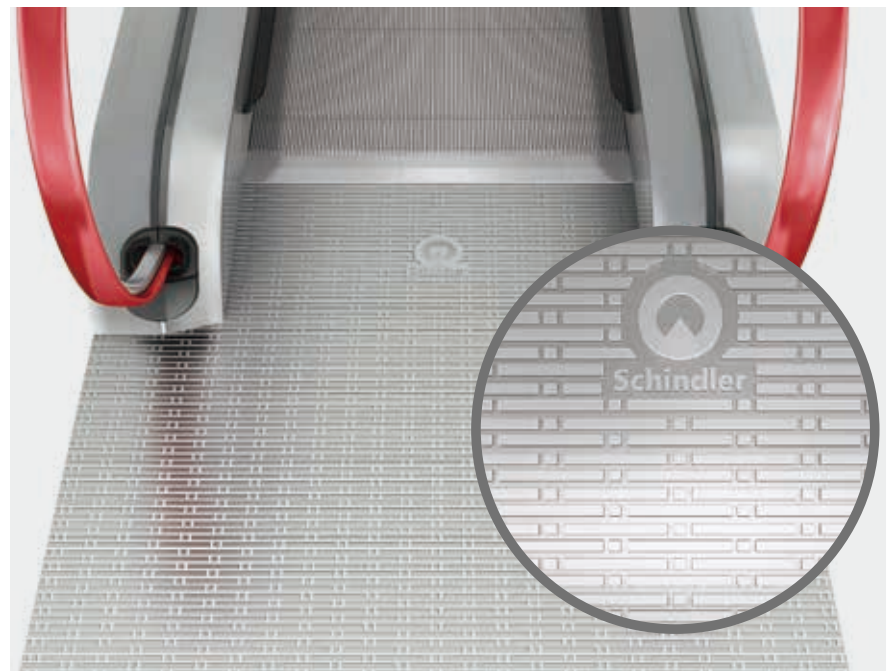

Stainless-steel floor cover with dotted-line pattern

Elegant adaptable design options

Schindler 9300 escalator offers not only timeless basic equipment, but also distinctive and highly customizable design options which easily adapt to smaller commercial areas and high-end shopping centers.

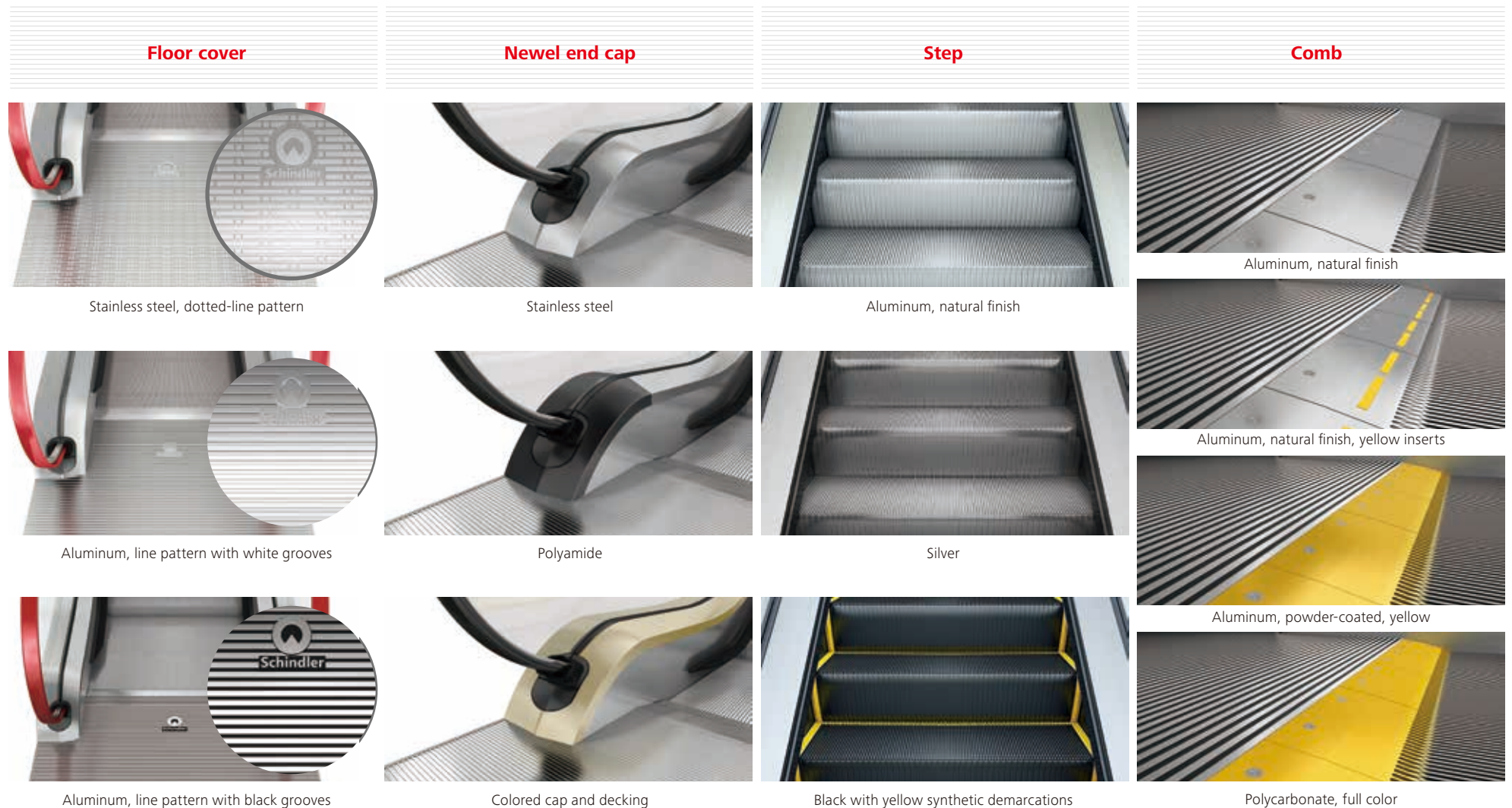



Would like to design an escalator yourself and review its appearance? Please scan the QR code on this page with an iPad and install the Schindler Escalator app. Then you can easily design your own escalator and view its 3D effect with the 3D Configurator in the Configurator model.

LED lighting



Skirt lighting, light strips



Skirt lighting, spots

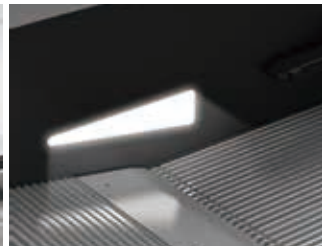

Comb lighting



Skirt lighting, green

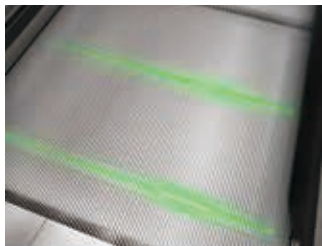

Step gap lighting



Integrated direction indicator



Balustrade lighting, blue



Balustrade lighting, purple

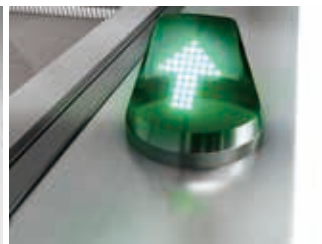

Outer decking direction indicator

Handrail



Black



Green



Red



Orange



Antimicrobial handrail



Safety signage handrail

Skirt panel

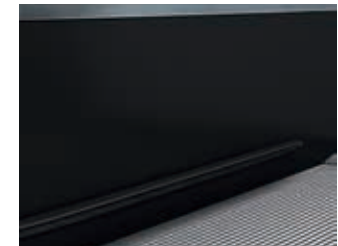

Sheet steel, black anti-friction



Stainless steel

Note:

Specifications, options, and colors are subject to change. All options illustrated in this brochure are representations only. The samples shown may vary from the original in color and material.

High-quality products and global services

Unified global production system boasts European design concepts

Across the globe, Schindler operates nine production units for escalators and key escalator components like steps, trusses, and controllers. The Shanghai Works factory is by far the biggest escalator plant in the industry. All our factories comply with global assembly and quality standards.

Customer-focused maintenance service

Schindler not only has a standard and strict maintenance process in place, but also guarantees global spare parts supply. Maintaining your escalator using Schindler manufactured spare parts, you can be confident it will stay in excellent working order.

Integrated TQM system ensures excellence in quality

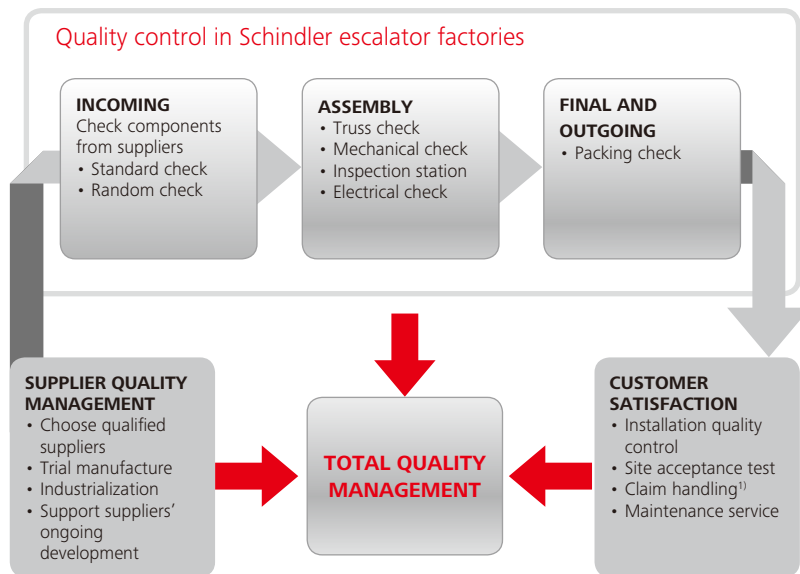

¹⁾ In case of claims for damaged or missing components, the factory's special claims handling team will help you analyze them.



Supporting details for easy planning

Nominal step width [mm]	600 / 800 / 1,000
Angle of inclination [degrees]	30 / 35
Max. rise H [m]	13
Balustrade height [mm]	900 / 1,000 / 1,100
Horizontal steps	2 / 3
Speed [m/s]	0.5 / 0.6 / 0.65

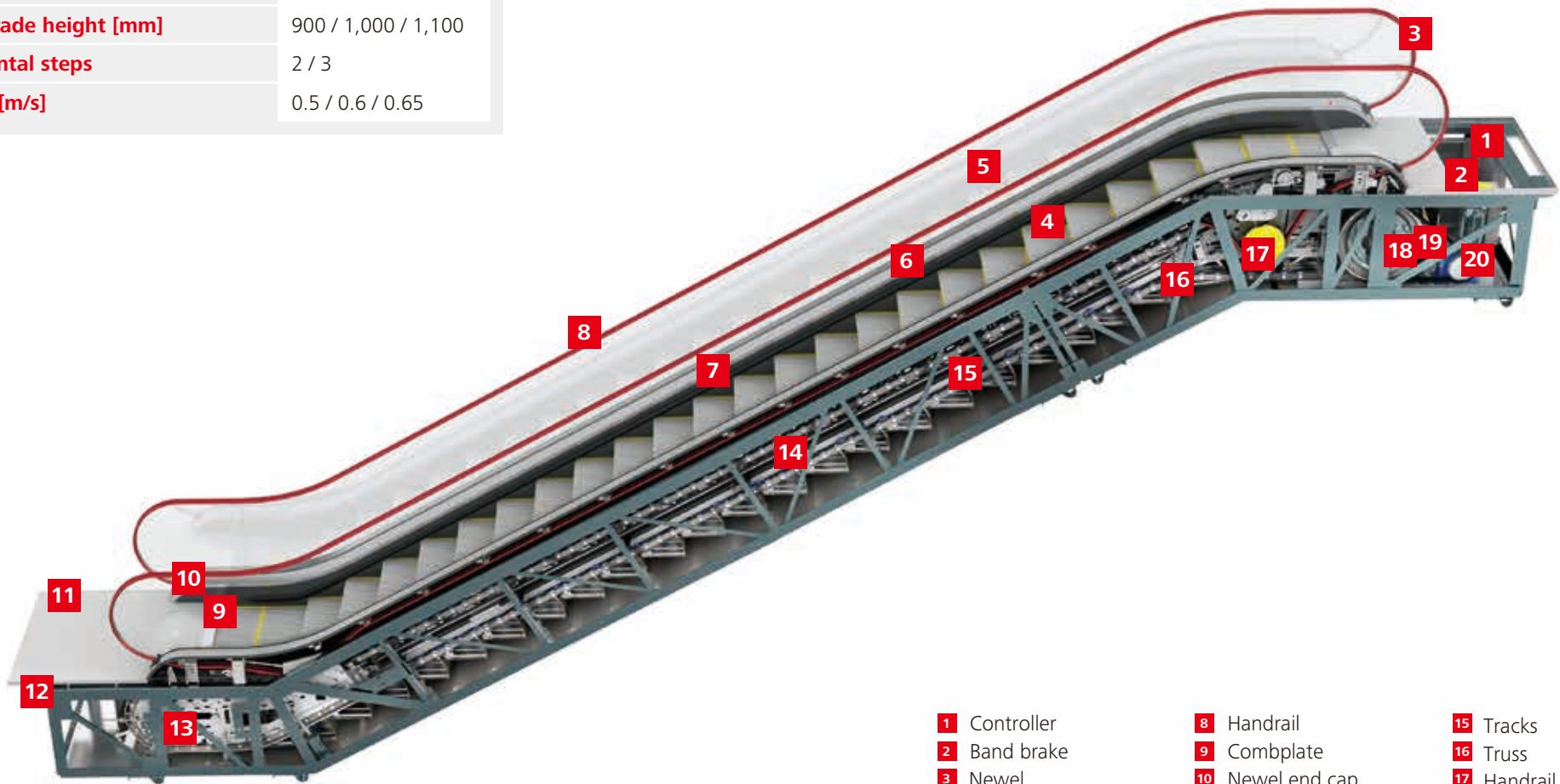

- | | | |
|------------------------------|---------------------------|--------------------------|
| 1 Controller | 8 Handrail | 15 Tracks |
| 2 Band brake | 9 Combplate | 16 Truss |
| 3 Newel | 10 Newel end cap | 17 Handrail drive |
| 4 Steps | 11 Floor covers | 18 Main shaft |
| 5 Balustrade | 12 End support | 19 Duplex chain |
| 6 Inner/outer decking | 13 Tension station | 20 Drive unit |
| 7 Skirting | 14 Step chain | |

Schindler 9300

30° inclination, rise up to 6 m

Balustrade:
design E

Balustrade height:
900 / 1,000 / 1,100 mm

Step width:
600 / 800 / 1,000 mm

Step run:
2 horizontal steps

Transition radius:
top/bottom: 1.0 m / 1.0 m

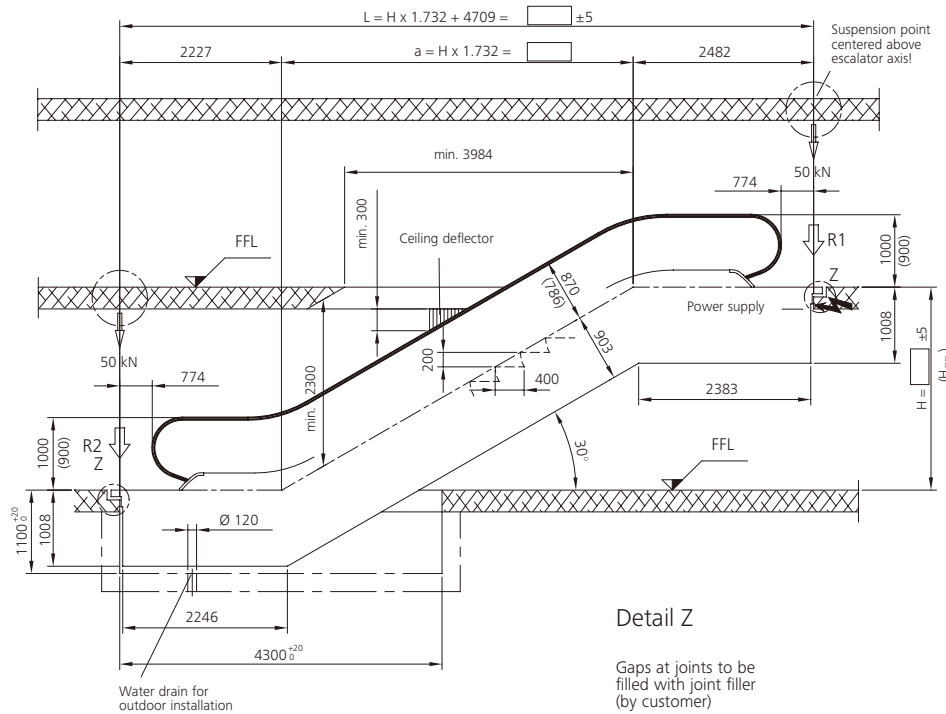

Transportation dimensions

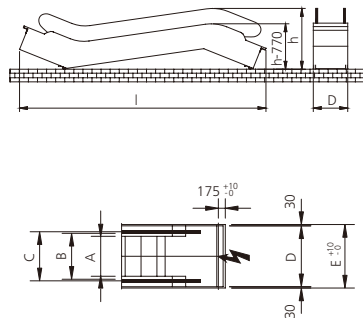

Detail Z

Gaps at joints to be filled with joint filler (by customer)

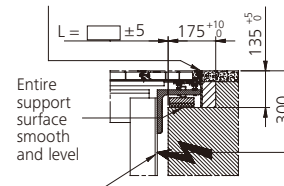

Inlet for lighting and power circuits centered at upper end, through front face

Note:

All dimensions in mm.
Observe national regulations!
Subject to change.

Step width [mm]	600	800	1,000
A: Step width	600	800	1,000
B: Width between handrails	750	950	1,150
C: Handrail outer distance	894	1,094	1,294
D: Width of escalator	1,065	1,265	1,465
E: Width of pit	1,125	1,325	1,525
H_{max}: Maximum rise	6,000	6,000	6,000

Step width [mm]	Rise [mm]	Weight [kN]	Support loads		Transp. dimensions Balustrade height 1,000	
			R1 [kN]	R2 [kN]	h [mm]	l [mm]
600	3,000	52	44	38	2,790	10,830
	3,500	56	47	41	2,810	11,820
	4,000	59	50	44	2,840	12,810
	4,500	62	53	47	2,850	13,800
	5,000	65	56	50	2,870	14,800
	5,500	69	58	53	2,880	15,790
800	3,000	55	50	45	2,790	10,830
	3,500	59	54	48	2,810	11,820
	4,000	62	57	52	2,840	12,810
	4,500	66	61	55	2,850	13,800
	5,000	69	64	58	2,870	14,800
	5,500	73	68	62	2,880	15,790
1,000	3,000	59	57	51	2,790	10,830
	3,500	62	61	55	2,810	11,820
	4,000	66	65	59	2,840	12,810
	4,500	70	69	63	2,850	13,800
	5,000	73	73	67	2,870	14,800
	5,500	81	79	73	2,880	15,790
6,000	85	83	77	2,890	16,790	

Schindler 9300

35° inclination, rise up to 6 m

Balustrade:
design E

Balustrade height:
900 / 1,000 / 1,100 mm

Step width:
600 / 800 / 1,000 mm

Step run:
2 horizontal steps

Transition radius:
top/bottom: 1.0 m / 1.0 m

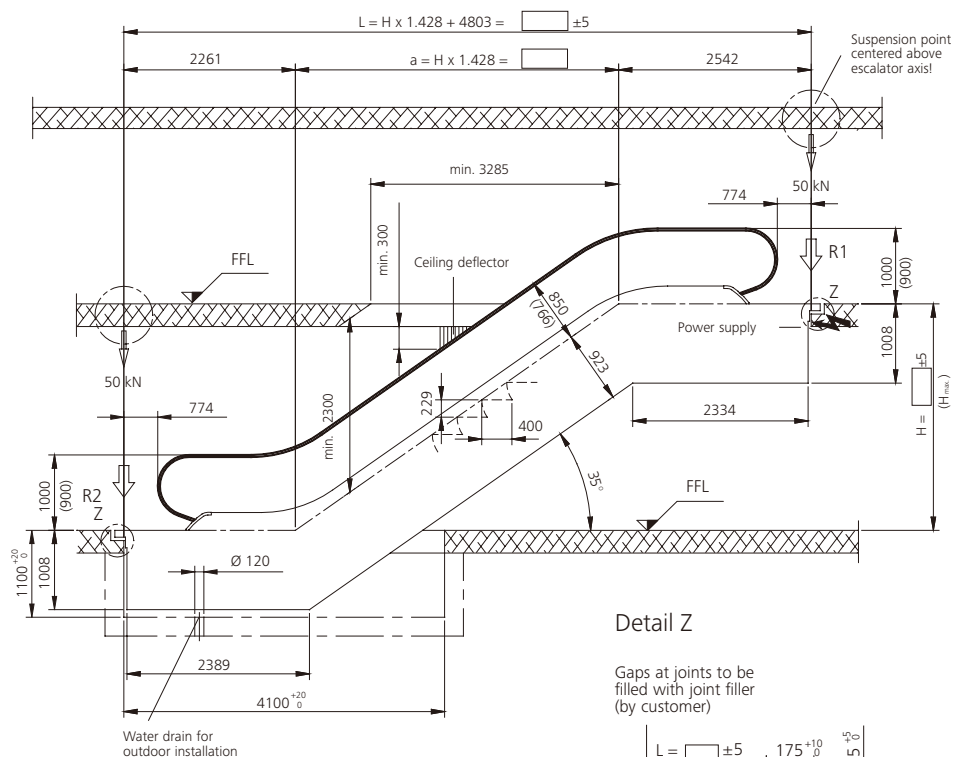

Transportation dimensions

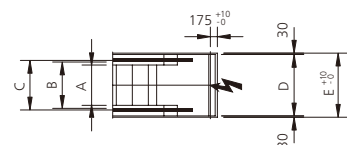
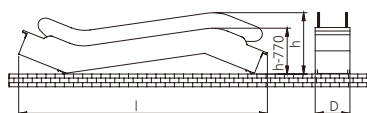

Detail Z

Gaps at joints to be filled with joint filler (by customer)

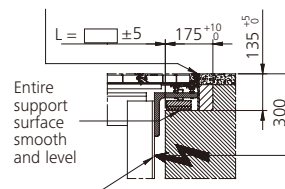

Inlet for lighting and power circuits centered at upper end, through front face

Note:

All dimensions in mm.
Observe national regulations!
Subject to change.

Step width [mm]	600	800	1,000
A: Step width	600	800	1,000
B: Width between handrails	750	950	1,150
C: Handrail outer distance	894	1,094	1,294
D: Width of escalator	1,065	1,265	1,465
E: Width of pit	1,125	1,325	1,525
H_{max}: Maximum rise	6,000	6,000	6,000

Step width [mm]	Rise [mm]	Weight [kN]	Support loads		Transp. dimensions Balustrade height 1,000	
			R1 [kN]	R2 [kN]	h [mm]	l [mm]
600	3,000	49	41	35	2,870	10,070
	3,500	52	44	38	2,910	10,920
	4,000	55	46	40	2,930	11,780
	4,500	58	49	43	2,950	12,640
	5,000	60	51	45	2,970	13,500
	5,500	63	53	48	2,980	14,360
800	3,000	52	47	41	2,870	10,070
	3,500	55	50	44	2,910	10,920
	4,000	58	53	47	2,930	11,780
	4,500	61	56	50	2,950	12,640
	5,000	64	59	53	2,970	13,500
	5,500	67	62	56	2,980	14,360
1,000	3,000	70	65	59	3,000	15,270
	3,500	75	70	64	2,910	10,920
	4,000	80	75	69	2,930	11,780
	4,500	85	80	74	2,950	12,640
	5,000	90	85	79	2,970	13,500
	5,500	95	90	84	2,980	14,360

Schindler 9300

30° inclination, rise up to 8.5 m

Balustrade:
design E

Balustrade height:
900 / 1,000 / 1,100 mm

Step width:
600 / 800 / 1,000 mm

Step run:
3 horizontal steps

Transition radius:
top/bottom: 1.0 m / 1.0 m

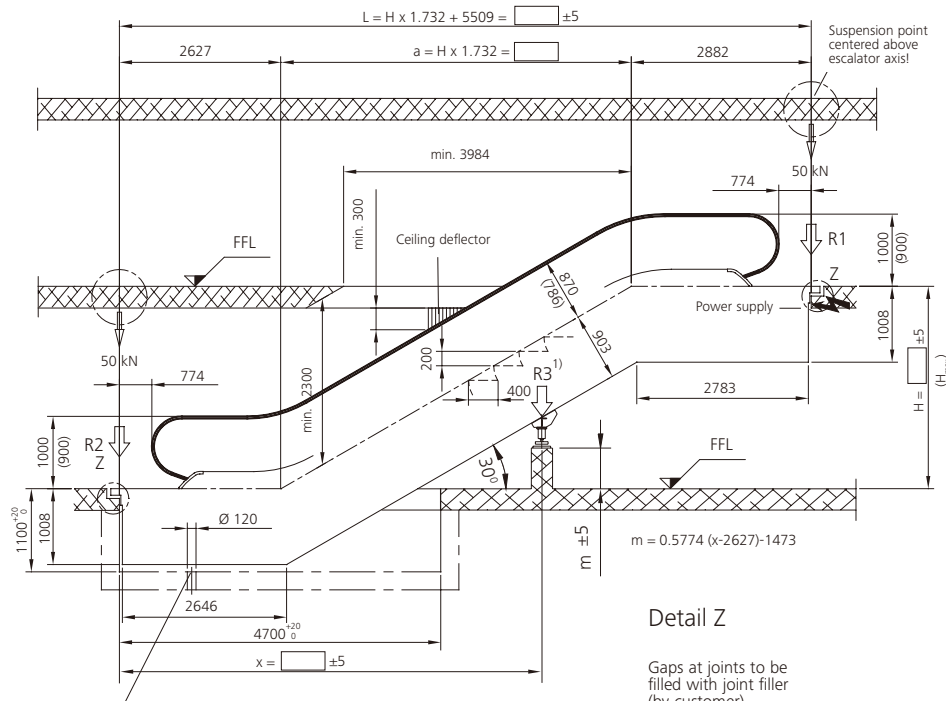

Water drain for outdoor installation

Transportation dimensions

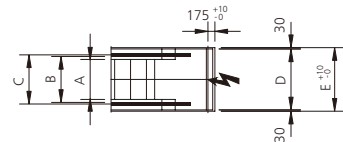
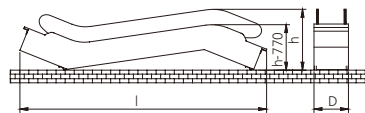

Detail Z

Gaps at joints to be filled with joint filler (by customer)

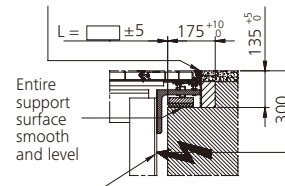

Inlet for lighting and power circuits centered at upper end, through front face

Note:

All dimensions in mm.
Observe national regulations!
Subject to change.

Step width [mm]	600	800	1,000
A: Step width	600	800	1,000
B: Width between handrails	750	950	1,150
C: Handrail outer distance	894	1,094	1,294
D: Width of escalator	1,065	1,265	1,465
E: Width of pit	1,125	1,325	1,525
H_{max}: Maximum rise	8,500	8,500	8,500

Step width [mm]	Rise [mm]	Weight [kN]	Support loads			Transp. dimensions Balustrade height 1000	
			R1 [kN]	R2 [kN]	R3 [kN]	h [mm]	l [mm]
600	3,000	52	44	38	-	2,900	11,570
	4,000	59	50	44	-	2,960	13,550
	5,000	65	56	50	-	²⁾	²⁾
	6,000	72	61	56	-	²⁾	²⁾
	7,000	88	42	34	68	²⁾	²⁾
	8,000	94	44	36	76	²⁾	²⁾
800	3,000	55	50	45	-	2,850	11,610
	4,000	62	57	52	-	2,910	13,580
	5,000	69	64	58	-	2,950	15,570
	6,000	76	71	65	-	²⁾	²⁾
	7,000	93	47	39	82	²⁾	²⁾
	8,000	100	49	41	92	²⁾	²⁾
1,000	3,000	59	57	51	-	2,850	11,610
	4,000	66	65	59	-	2,910	13,580
	5,000	73	73	67	-	2,950	15,570
	6,000	85	83	77	-	²⁾	²⁾
	7,000	99	52	44	96	²⁾	²⁾
	8,000	106	55	47	107	²⁾	²⁾
8,500	110	56	48	113	²⁾	²⁾	

¹⁾ For $H > 6$ m, an intermediate support may be required. Please consult Schindler.

²⁾ Delivery in 2 parts.

Schindler 9300

Type 15, 30° inclination, rise up to 13 m

Balustrade:
design E

Balustrade height:
900 / 1,000 / 1,100 mm

Inclination:
30°

Step width:
800 / 1,000 mm

Step run:
3 horizontal steps

Transition radius:
top/bottom: 1.5 m / 1.0 m

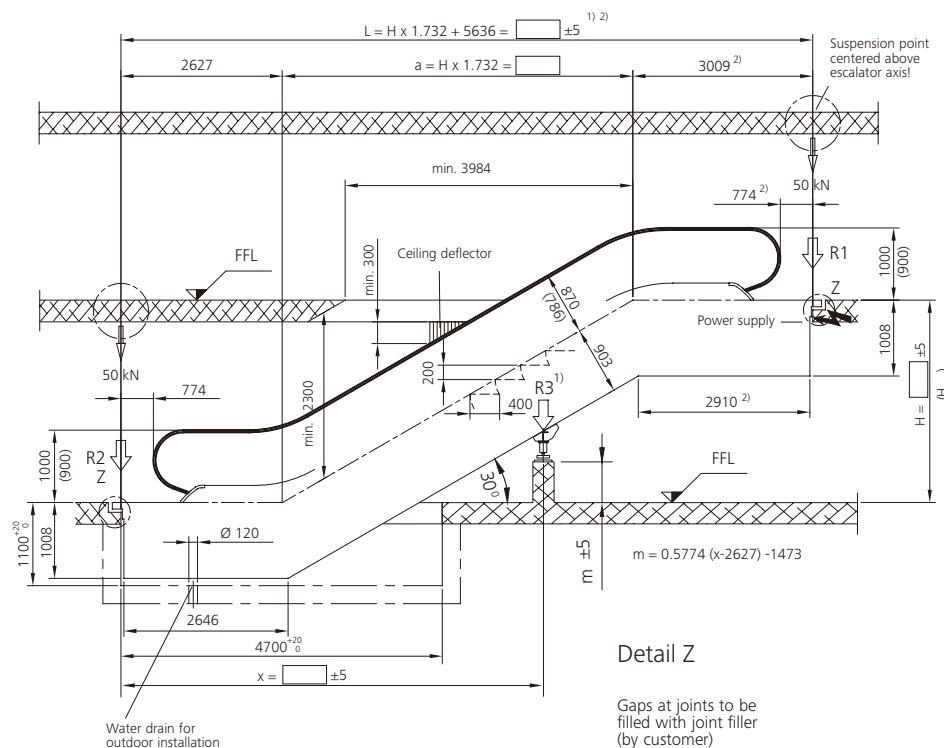

Water drain for outdoor installation

Transportation dimensions

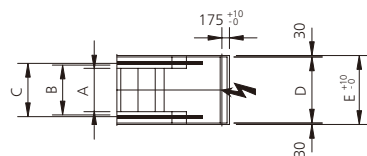
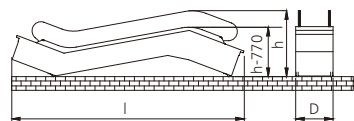

Detail Z

Gaps at joints to be filled with joint filler (by customer)

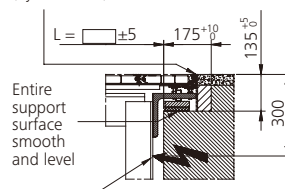

Inlet for lighting and power circuits centered at upper end, through front face

Note:
All dimensions in mm.
Observe national regulations!
Subject to change.

Step width [mm]	800	1,000
A: Step width	800	1,000
B: Width between handrails	950	1,150
C: Handrail outer distance	1,094	1,294
D: Width of escalator	1,265	1,465
E: Width of pit	1,325	1,525
H_{max}: Maximum rise	13,000	13,000

Step width [mm]	Rise [mm]	Weight [kN]	Support loads			Transp. dimensions Balustrade height 1,000	
			R1 [kN]	R2 [kN]	R3 [kN]	h [mm]	l [mm]
800	3,000	62	56	49	-	2,930	11,690
	4,000	69	63	56	-	3,000	13,670
	5,000	76	70	63	-	3,050	15,650
	6,000	85	78	71	-	3,080	17,630
	7,000	93	52	30	88	³⁾	³⁾
	8,000	101	55	33	97	³⁾	³⁾
	9,000	111	53	44	104	³⁾	³⁾
	10,000	119	56	47	114	³⁾	³⁾
	11,000	126	59	49	123	³⁾	³⁾
	12,000	133	61	52	133	³⁾	³⁾
1,000	3,000	66	63	57	-	2,930	11,690
	4,000	100	49	41	-	3,000	13,670
	5,000	103	50	42	-	3,050	15,650
	6,000	59	57	51	-	3,080	17,630
	7,000	99	59	34	103	³⁾	³⁾
	8,000	107	61	38	113	³⁾	³⁾
	9,000	118	60	50	121	³⁾	³⁾
	10,000	126	63	53	132	³⁾	³⁾
	11,000	140	69	60	142	³⁾	³⁾
	12,000	154	78	63	154	³⁾	³⁾
13,000	163	81	66	165	³⁾	³⁾	

¹⁾ For H > 8.5 m, a second intermediate support may be required. Please consult Schindler.

²⁾ For H > 8.5 m, a top extension of 417 mm is needed.

³⁾ Delivery in 2 parts.

You know where to find us. We look forward to seeing you.

For additional information and the location of your
nearest Schindler branch, please visit:

www.schindler.com

This publication is for general informational purposes only and we reserve the right at any time to alter the services, product design, and specifications. No statement contained in this publication shall be construed as a warranty or condition, expressed or implied, as to any service or product, its specifications, its fitness for any particular purpose, merchantability, or quality nor shall be interpreted as a term or condition of any service or purchase agreement for the products or services contained in this publication. Minor differences between printed and actual colors may exist.